

Gas Chromatography/ Mass Spectrometry

Authors:

Andrew Tipler

Sheila Eletto

PerkinElmer, Inc.

Shelton, CT

The Characterization of Perfume Fragrances Using GC/MS, Headspace Trap and Olfactory Port

Introduction

The genesis of perfume fragrances can be traced back to the Stone Age and has evolved into a multi-billion-dollar industry today. Humans historically used scents for medical

effect and for masking body odors. In the modern world, perfume fragrances play a more complex role and they remain extremely popular for both women and men. The quality of a fragrance is now measured more by the sophistication of its bouquet rather than by its strength and, so knowledge of its composition becomes of greater interest to the producers.

Modern perfume fragrances are mixtures of natural and synthetic essential oils and aroma compounds based in a suitable solvent vehicle, such as ethanol or an ethanol and water mixture. Diluted versions are known as eau de cologne and toilet water. These aromatic compounds are organic in nature and must be volatile at body temperatures in order to be effective. Analysis by gas chromatography (GC) is an ideal way to separate, identify and quantify the content of most perfume fragrances. The use of mass spectrometry (MS) further assists by providing the means to identify the components in a gas chromatogram.

Another key component in such an analytical system is the sample handling system. In this case, headspace (HS) sampling is a very suitable means of delivering the volatile organic compounds (VOCs) into the GC column. Sample preparation simply requires placing a known amount of sample into a suitable vial and the headspace sampling device does the rest. One potential concern with the classical HS technique is that only a small fraction of the sample reaches the GC column. The use of a HS Trap system enables much more of the volatile material to be collected and delivered to the GC column to help detect and monitor compounds at much lower concentrations in the sample.

While a combined HS-Trap GC/MS system provides a very effective means to analyze perfumes chemically, it does not provide direct insight into the odor contribution made by each of the chemical compounds. The inclusion of an olfactory port into the analytical system enables the user to get both hard chemical analysis data and a sensory characterization of each sample from a single run. Such information provides the user with a much fuller profile of each sample to enable key decisions to be made by the producer.

Such information would help with:

- Quality control of raw materials
- Quality control of final product
- Product development
- Off-odor trouble-shooting
- Reverse engineering competitive products
- Storage studies

This application note describes a system, method and some typical results for the chemical and olfactory evaluation of eau de cologne samples.

Analytical System

The analytical system comprises five main components:

HS Trap

Static headspace sampling is very suited for extracting aroma compounds out of perfume. It also more accurately represents how the perfume is used rather than by making a direct injection of the eau de cologne into the GC.

A small metered amount of perfume is placed in a glass vial and sealed as shown in Figure 1. This vial is then heated in an oven at a fixed temperature and for a set time. Because such a small amount of sample is deposited in the vial, effectively all the volatile compounds become vaporized. A portion of the vapor is then extracted from the vial by the headspace sampling system and introduced into the GC column for separation and analysis.

While extremely convenient, static headspace sampling only delivers a very small fraction of the headspace vapor into the GC column and so it is really best suited to high concentrations of compounds. In the analysis of complex samples, it is often found that low levels of some components are critical to the overall aroma of that sample. To increase the amount of sample value introduced into the GC column, a TurboMatrix™ HS trap system was used.



Figure 1. Introducing an eau de cologne sample into a HS vial.

Using this technology, most or even the entire headspace vapor is passed through an adsorbent trap to collect and focus the VOCs. The trap is then rapidly heated and the desorbed components are transferred to the GC column. In this way, the amount of sample vapor entering the GC column can be increased by a factor of up to 100x.

Some of the water in the sample will remain in the vial and most of the water vapor that travels to the trap will be removed by dry purging. This HS Trap technique is very effective at delivering the volatile content of a sample like perfume into a GC column without the water which would otherwise degrade the column or detector. Figure 2 to Figure 4 show how the HS Trap system operates.

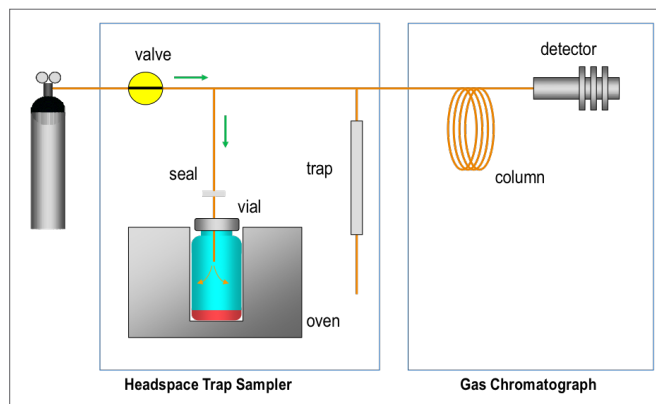

Figure 2. Schematic diagram of the HS Trap system showing the equilibrated vial being pressurized with carrier gas.

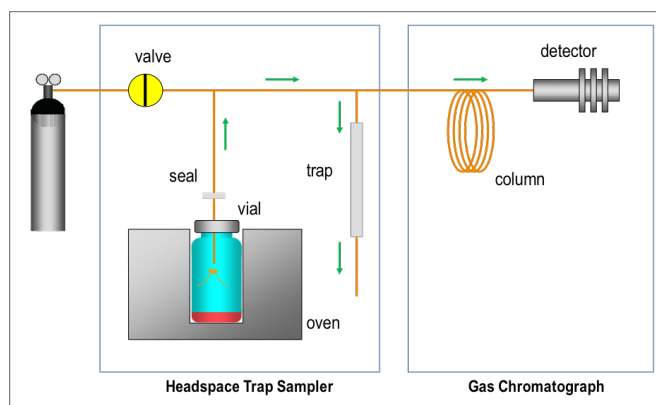

Figure 3. Schematic diagram of the HS Trap system showing the pressurized headspace being released from the vial into the adsorbent trap.

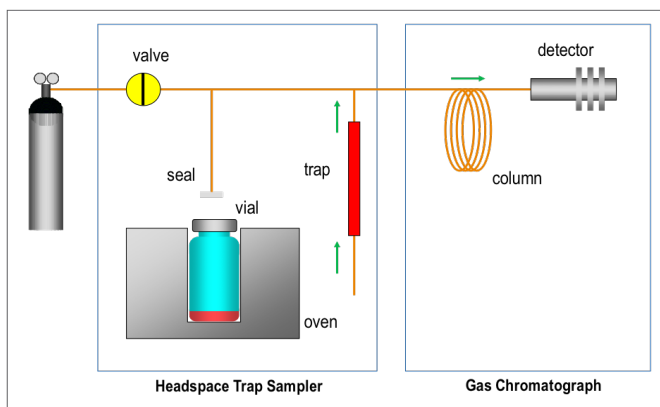

Figure 4. Schematic diagram of the HS Trap system showing the VOCs collected in the adsorbent trap being thermally desorbed and introduced into the GC column.

Figure 2 to Figure 4 are simplified representations of the HS Trap operation (there are other valves and plumbing needed to ensure that sample vapor goes where it should and not anywhere else). Essentially, the principle is very similar to classical static headspace but at the end of the vial equilibration step, after the vapor is pressurized, it is fully vented through an adsorbent trap. This process may be repeated to effectively vent the entire headspace vapor through the adsorbent trap. Once the trap is loaded, it is rapidly heated and the desorbed VOCs are transferred to the GC column.

The Clarus 680 GC

The workhorse Clarus® 680 GC is an ideal complement to the rest of the system. The chromatography is undemanding so simple methods may be used. For olfactory monitoring, it is important to have sufficient time between adjacent peaks for the user to discern them from each other. It is also beneficial to load the column with as much sample as possible without overload to provide the best opportunity for the user's nose to detect them. For this reason, a long column with a thick stationary phase is used. Because many of the components in perfume are highly polar (acids, esters, ketones, etc.) a very polar Carbowax®-type stationary phase is used for the separation.

Figure 5 shows a photograph of the complete Clarus GC/MS System.



Figure 5. The Clarus GC/MS System.

The S-Swafer System

Because the column effluent needs to supply both the MS and the olfactory port, some form of splitting device is required. This should not affect the integrity of the chromatography in any way and so should be highly inert and have low-volume internal geometry. The use of a make-up gas in the splitter provides additional control and stability of the split flow rates.

The S-Swafer™ is an excellent active splitting device and well suited to this purpose. Figure 6 shows the S-Swafer configured to split the column effluent between the MS detector and the GC SNFR™ Olfactory Port. The split ratio between the detector and the olfactory port is defined by the choice of restrictor tubes connected between the Swafer outlets and the MS and SNFR.

The Swafer Utility Software which is included with the Swafer system may be used to calculate this split ratio. Figure 7 shows how this calculator was used to establish the operating conditions for the S-Swafer for this application.

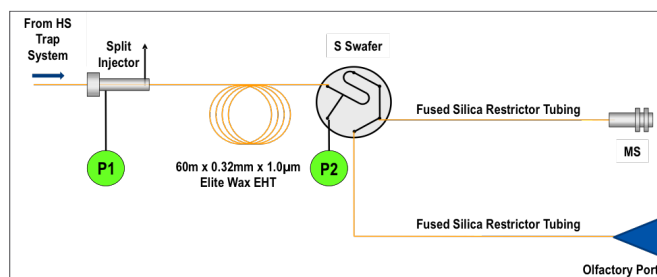

Figure 6. S-Swafer configured for use with the Clarus SQ 8 GC/MS and the GC SNFR Olfactory Port.

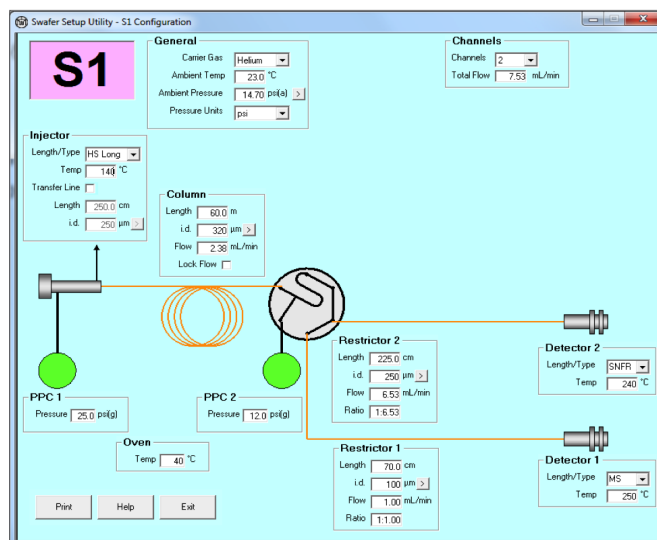

Figure 7. The Swafer Utility Software showing the settings used for this aroma characterization work.

The Clarus SQ 8 Mass Spectrometer

A mass spectrometer is an important part of an aroma characterization system. It's important to detect and quantify the various compounds eluting from the GC column. The Clarus SQ 8 quadrupole mass spectrometer is ideally suited for this purpose and will quickly identify and quantify components using classical spectra in the supplied NIST library. This software is also able to interact with the olfactory information as described later in this document.

The GC SNFR Olfactory Port Accessory

Figure 8 shows a view of the GC SNFR accessory. This is connected to the GC via a flexible heated transfer line. The split column effluent travels to the glass nose-piece through deactivated fused silica tubing.

While monitoring the aroma compounds eluting from the GC column, the user is able to capture vocal narration via an in-built microphone and aroma intensity by adjustment of a joystick.



Figure 8. The GC SNFR Olfactory Port accessory.

Analytical Conditions

Table 1. HS Trap conditions.

Headspace System	TurboMatrix 110 HS Trap
Vial Equilibration	80 °C for 15 minutes
Needle	120 °C
Transfer Line	140 °C, column connected directly to HS Trap
Carrier Gas	Helium at 25 psig
Dry Purge	5 min
Trap	Air Toxics, 30 °C to 300 °C, hold for 5 min
Extraction Cycles	1 with 40 psig extraction pressure

Table 2. GC conditions.

Gas Chromatograph/ Mass Spectrometer	Clarus SQ 8
Column	60 m x 0.32 mm x 1.0 µm Elite-SMS connected directly to the HS Trap
Oven	40 °C for 2min, then 4 °C/min to 240 ° for 8 min
Carrier Gas	13 psig at Swafer
Injector	PSS at 300 °C, carrier gas off

Table 3. MS conditions.

Scan Range	m/z 35 to 350
Scan Time	0.8 s
Interscan Delay	0.1 s
Source Temp	250 °C
Inlet Line temp	250 °C

Table 4. Olfactory port conditions.

Olfactory Port	PerkinElmer GC SNFR
Transfer line	225 cm x 0.250 mm at 240 °C
Humidified air	500 mL/min with jar set to 37 °C

Table 5. Swafer conditions.

Swafer	PerkinElmer S-Swafer in the S1 configuration
Settings	Developed using the Swafer Utility Software – see Figure 7

Table 6. Sample details.

Sample preparation	25 µL of each fragrance was delivered by micro syringe into a sample vial and immediately sealed
Vial	Standard 22-mL vial with aluminum crimped cap with PTFE lined silicone septum

Typical Chromatography

Figure 9 shows total ion chromatograms (TIC) of three perfume samples with the identities annotated for some of the key components established by the MS. Part of the Fragrance A chromatogram is highlighted and is expanded in Figure 10. The power of the MS enables a particular peak to be identified from its mass spectrum (as shown in Figure 11) by searching the NIST spectral library supplied with the Clarus SQ 8 system. The results of this search are given in Figure 12. The results of this search very

strongly indicate that the peak eluting at 44.46 minutes is, α -methyl-acetate benzene methanol, otherwise known as Gardenol. Gardenol is a very distinctive aroma compound and will provide a strong, radiant, herbal-green-fruity, floral aroma similar to that of the gardenia flower. The amount of gardenol (or any other compound once identified) may be quantified by calibrating the GC/MS with standard mixtures of this compound.

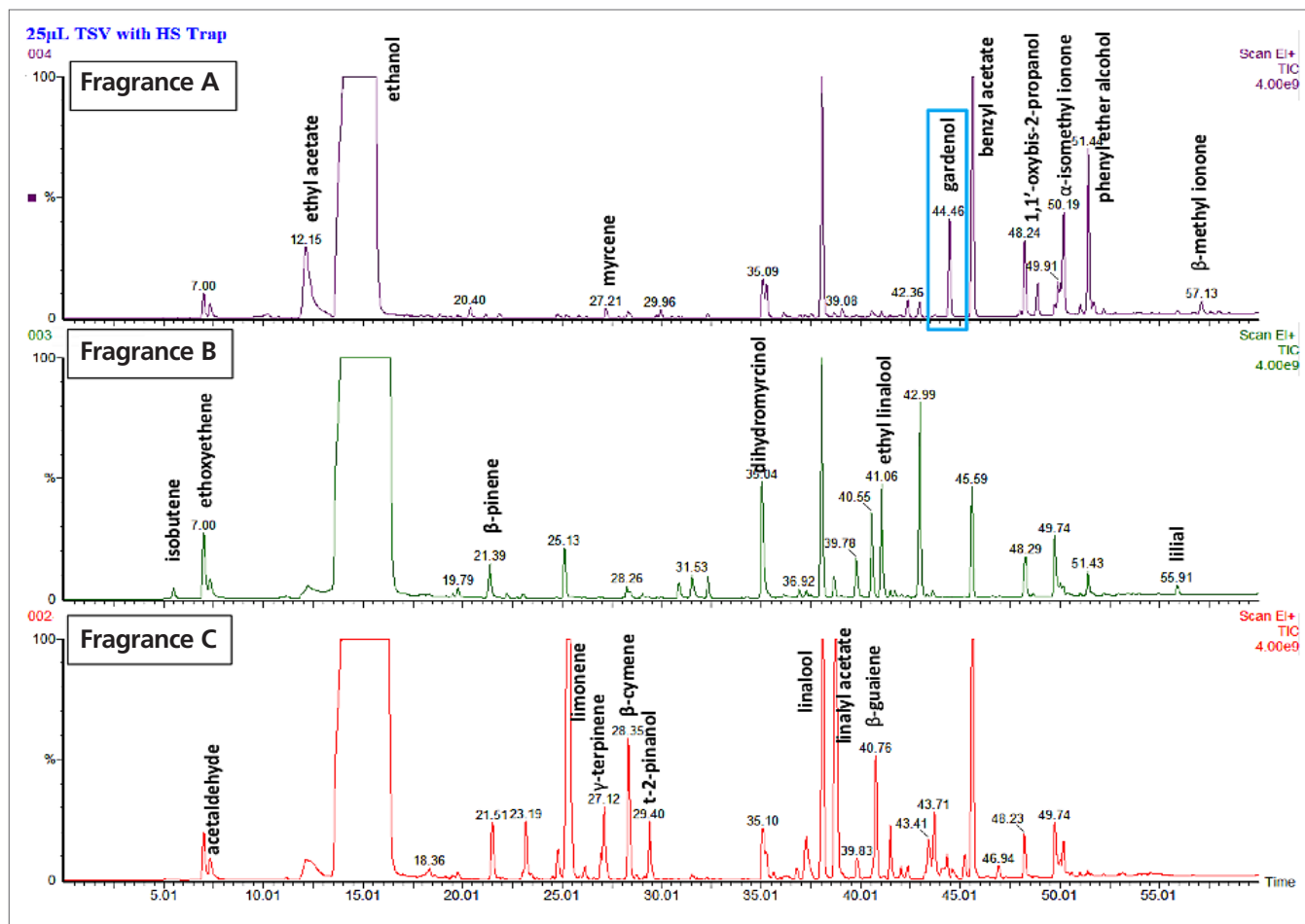

Figure 9. Typical TIC chromatograms of three fragrance samples.

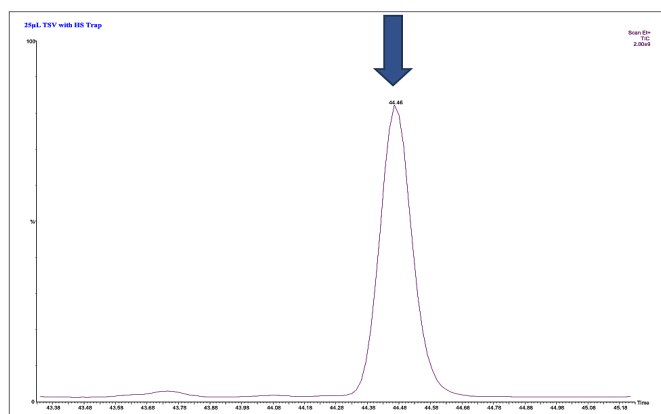

Figure 10. Highlighted detail from Figure 9.

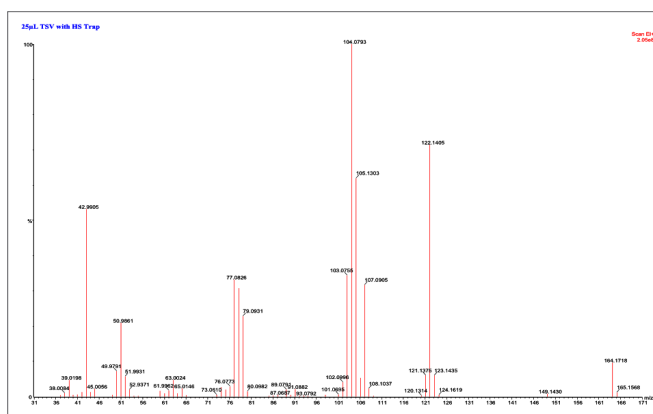

Figure 11. Mass spectrum from peak highlighted in Figure 10.

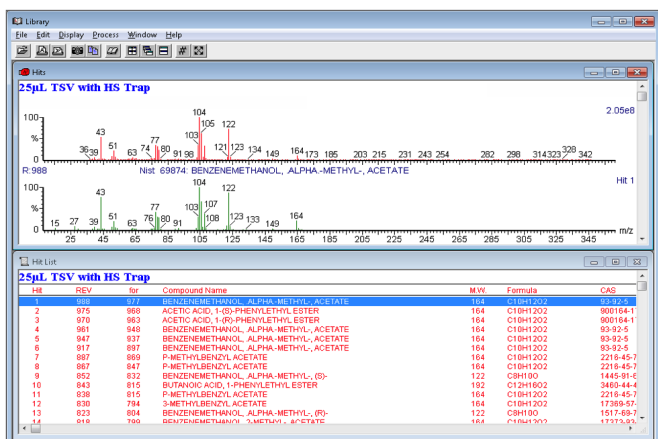

Figure 12. Results from library search on mass spectrum shown in Figure 11 indicating the presence of α -methyl-acetate benzene methanol, otherwise known as Gardenol.



Figure 13. Ms. Sheila Eletto, co-author and amateur fragrance expert, using the SNFR device.

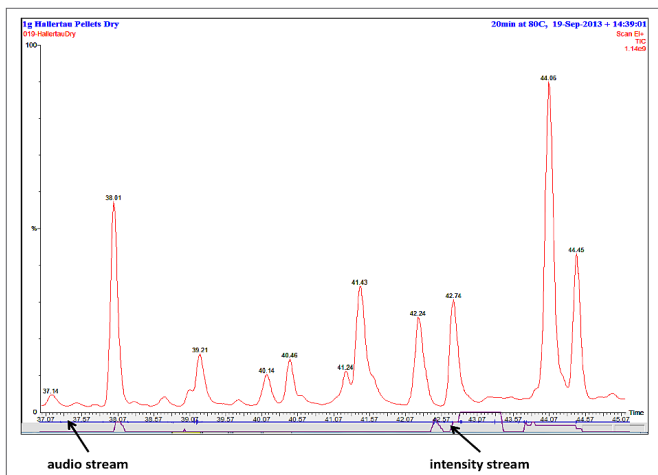

Figure 14. Example of a chromatogram being reviewed within the TurboMass™ software with the audio narration and aroma intensity graphically overlaid.

By performing further identifications of the chromatographic peaks, a profile of the fragrance composition may be established.

Olfactory Characterization

Figure 13 shows the GC SNFR Olfactory Port in use by a fragrance expert. The operator sees the chromatogram developing on the monitor screen which is normally located behind the SNFR device. In this instance the boom microphone on the headset is used to record the narration and the joystick is near at hand to input the aroma intensity.

Figure 14 shows an example of a chromatogram with the audio narration and intensity recordings graphically overlaid. The audio narration is stored in a standard WAV file format that may be replayed from this screen to the operator by means of a simple mouse-click. The narration WAV may also be played back from most media applications including the Microsoft® Media Player, which is included with the Windows® operating systems.

The audio data may be transcribed into text at the time of the recording. The Nuance® Dragon® Naturally Speaking Software performs this function. It is included in the GC SNFR product.

Conclusions

The addition of an olfactory port to a headspace GC/MS system extends its application for aroma characterization of samples such as perfume fragrances. The ability to directly correlate organoleptic perception against hard analytical data provides insights difficult to obtain otherwise.